

Features & Benefits

Quantum® Sliding Door

- 1 Energy Efficiency Options
Trend® Thermashield® in various glazing styles are available to help reduce energy consumption. Trend® Thermashield® means greater control, bigger savings and most importantly one less thing to worry about. Energy efficient options to u-value of 3.0 and SHGC 0.41 are available for Quantum Sliding Door.
- 2 Acoustic options
SoundMizer® acoustic solutions in various STC rating are available to STC 38 for Quantum Sliding Door. SoundMizer® acoustic solutions can reduce aircraft, highway traffic, railway and other annoying noise problems. For information or technical details contact Trend®.
- 3 Locks
Sliding doors are fitted with double cylinder deadlock as standard
- 4 Safety Glazing
Toughened Safety A Grade Glass with a visual motif at the mid point to provide added safety. Laminated Glass is used in all non standard door sizes.
18mm Double Glazing is available for energy efficiency requirements.
- 5 Protected Rolling Track
An extruded aluminium splayed threshold protects both glass door and flydoor rolling tracks.
- 6 Simple Access
The aluminium threshold features the Easyrider™ sill which is ideal for wheelchair access.
- 7 Heavy Duty Rollers
Quantum door uses a heavy duty, double bogey roller system for smooth operation.
The marine alloy aluminium carriage reduces the chance of corrosion ensuring a long and smooth operation.
- 8 Frames
Quantum Door frame is 101.6mm wide with the sash 50mm wide. Reminiscent of timber, Quantum Sliding Door is extremely popular in both traditional and contemporary house designs.
Maximum Door Height is 2700mm.
Maximum Door Panels 1500mm
- 9 Interlockers
Five types of interlockers are available. Quantum Door rates to 2200 pascals (kPa) - structural.
- 10 Optional Heavy Duty Barrier and Insect Screen Door
The sturdy extruded aluminium, external sliding flydoor is fitted with spring loaded acetal wheels that ensure the insect screen door stays on the track and opens smoothly.
- 11 Build-In Accessories
 - 180° non-load-bearing couplers.
 - 135° non-load-bearing corner couplers.
 - 100mm aluminium architraves for replacement door installations.
 - Adjustable aluminium storm mould.
 - Extruded aluminium 180° mullion covers to hide load-bearing posts.
- 12 Security
Quantum Sliding Door has a double parrot beak with a 2 point locking system. Striker plate is mounted with full fixing to jamb for added security.
- 13 Protective Wrapping
Protective wrapping for delivery to site is optional for all Quantum sliding door product.
- 14 Options
Colonial Bar, Federation Bar Layouts and Ovolo adaptor are available.
Wide range of powdercoat finishes including timber finishes available.

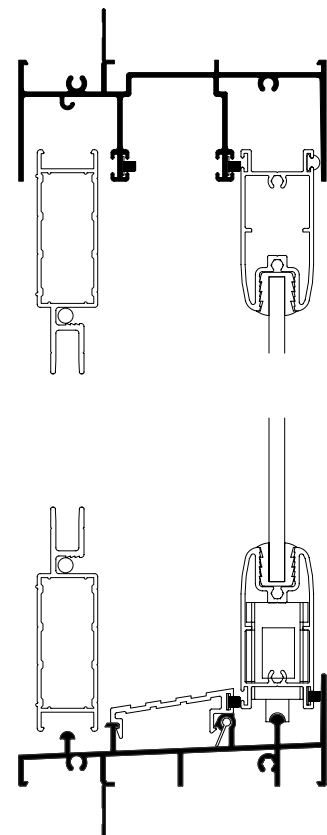

Please note that drawings are not to scale

Quantum® Sliding Door | QXD | Mk-4 | 1 Jul 2009

Size Range

Quantum® Sliding Door

		1626	1856	2226	2456	3066
STUD OPENING	2756	1570	1800	2170	2400	3010
	2456					
	2100					
DOOR SIZE	2756					
	2456	QXD2116	QXD2118	QXD2122	QXD2124	QXD2130
	2100	QXD2416	QXD2418	QXD2422	QXD2424	QXD2430
		QXD2716	QXD2718	QXD2722	QXD2724	QXD2730
		2768	3323		3668	
STUD OPENING	2756	2712	3267		3612	
	2456					
	2100					
DOOR SIZE	2756					
	2456	QXD2127	QXD2132	QXD2136		
	2100	QXD2427	QXD2432	QXD2436		
		QXD2727	QXD2732	QXD2736		
		3624	4364		4824	
STUD OPENING	2756	3568	4308		4768	
	2456					
	2100					
DOOR SIZE	2756					
	2456	QXXD2135	QXXD2143	QXXD2148		
	2100	QXXD2435	QXXD2443	QXXD2448		
		QXXD2735	QXXD2743	QXXD2748		

All windows and doors are designed to 700pa velocity and 150pa water rating. For higher ratings consult Quantum® Windows & Doors

Please note that drawings are not to scale

Quantum® Sliding Door | QXD | Mk-4 | 1 Jul 2009

Ordering Details

Quantum® Sliding Door

All doors are illustrated as viewed from outside.

Codes shown are for plain doors. The first two numbers of code indicate approximate height, the last two numbers indicate approximate width.

Sash Style Options:

Standard option, eg door code QXD2118

O indicates ovolo sash style, eg door code QOXD2118

T indicates Thermashield® double glazed sash style, eg door code QTXD2118

M indicates Acoustic sash style (SoundMizer®), eg door code QMXD2118

S indicates Sump Sill, eg door code QSXD2118

Bar Options:

CL indicates Colonial Bar, eg door code QXD2118CL

FD indicates Federation Bar, eg door code QXD2118FD

Configuration Options:

XF indicates Sliding/Fixed

FX indicates Fixed/Sliding

FXF indicates Fixed/Sliding/Fixed

FXXF indicates Fixed/Sliding/Sliding/Fixed

General:

Black hardware is supplied as standard
Two and Three panels doors available as reverse to brochure. Four panel doors have a prefix of QXXD.

* Also available in Colonial, Federation and Ovolo design styles.

Note:

Door heights not available in all wind pascal ratings. For information on double-glazing, different glass types or wind ratings, please contact a Trend® Windows & Doors sales representative. Pa refers to Pascal rating (wind pressure).

Installation

Quantum® Sliding Door | Building In Detail | **Brick Veneer - 230mm wall**

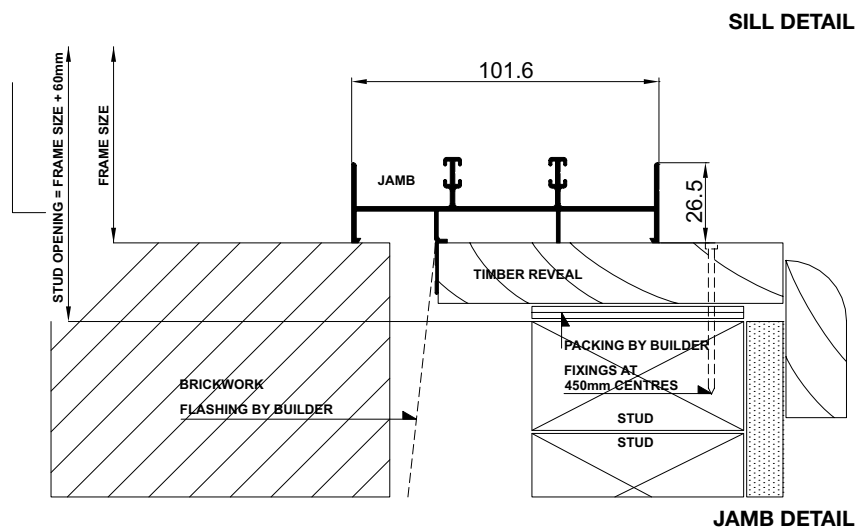
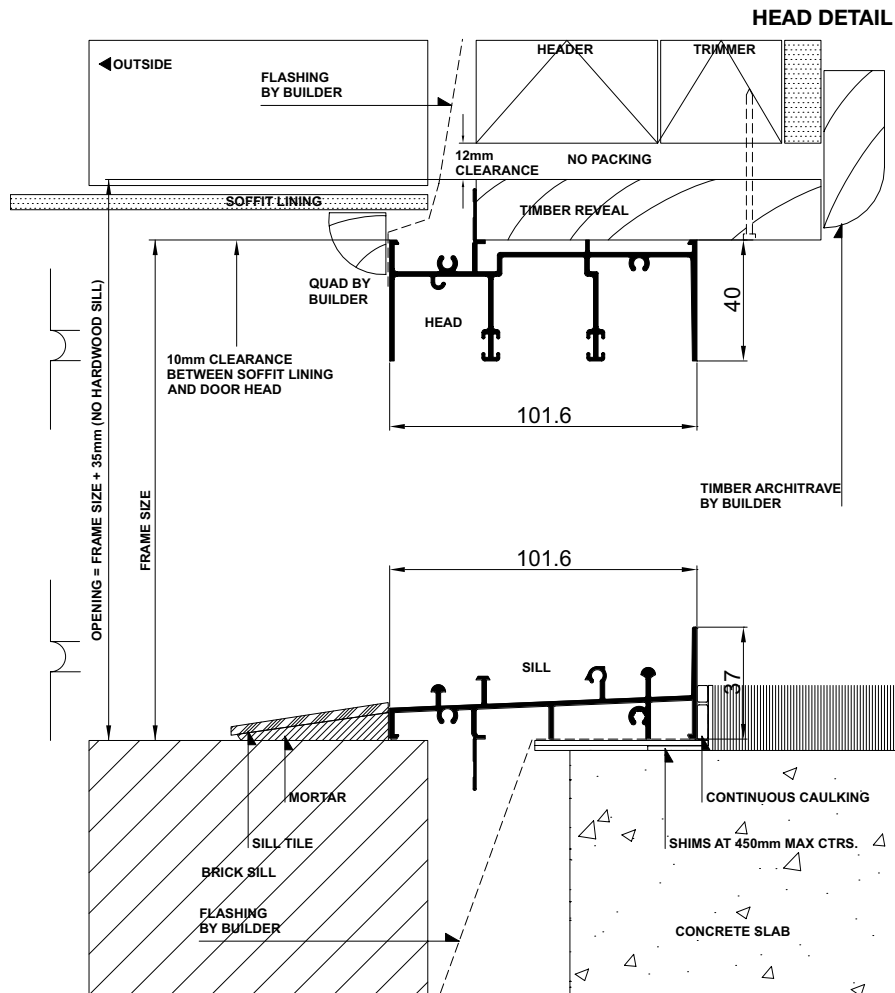

Please note that drawings are not to scale

Quantum® Sliding Door | QXD | Mk-4 | 1 Jul 2009

Installation

Quantum® Sliding Door | Building In Detail | **Double Brick - 280mm wall**

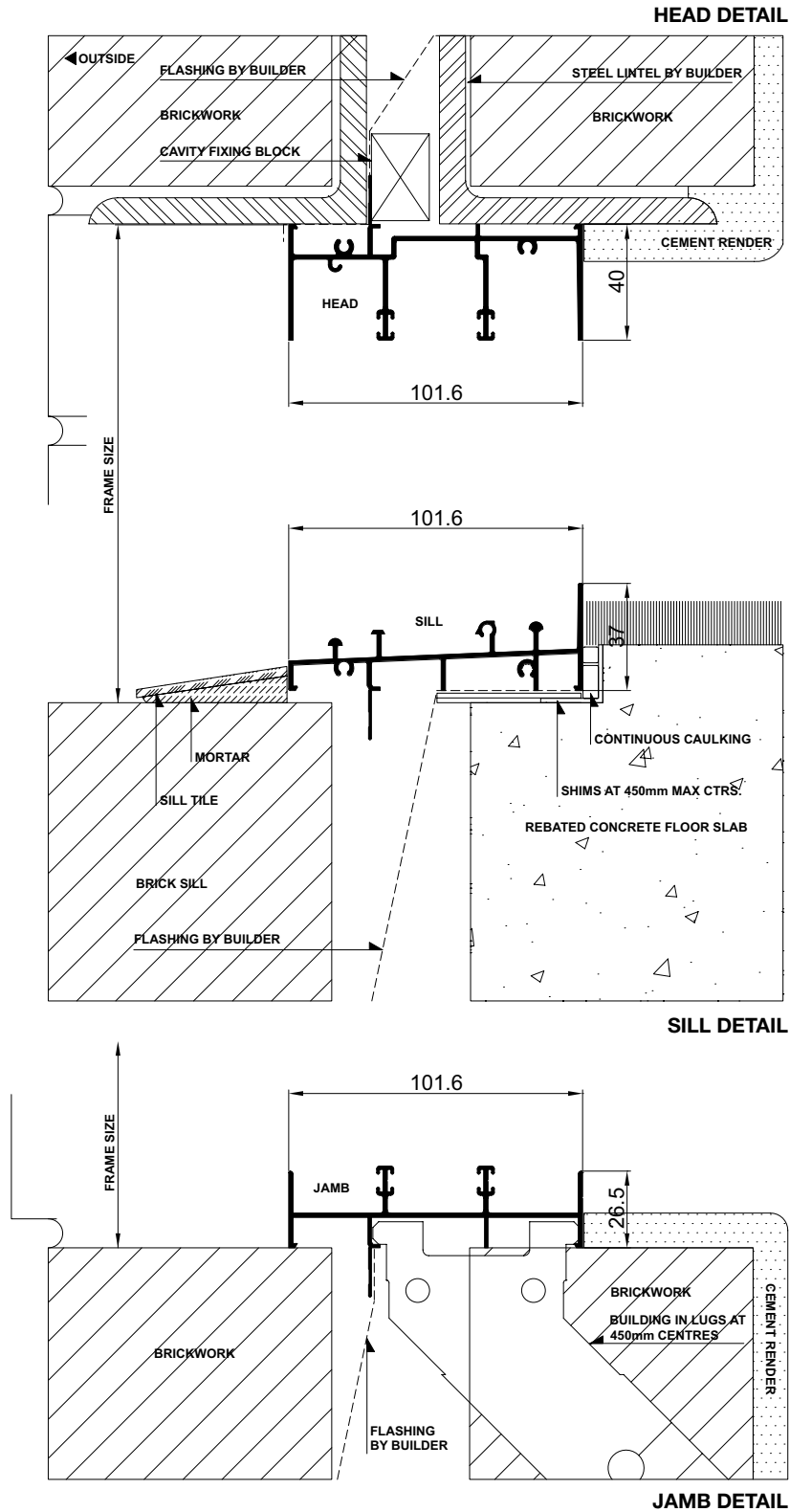

Please note that drawings are not to scale

Quantum® Sliding Door | QXD | Mk-4 | 1 Jul 2009

Confidentiality Notice: This document and the information it contains are copyright and confidential to Trend® Windows & Doors Pty Limited. Disclosure, use and copying in any form whatsoever, except as authorised by Trend® Windows & Doors in writing, are strictly prohibited. Patents and Design Registrations pending.

Installation

Quantum® Sliding Door | Building In Detail | **Aluminium Cladding on Studs**

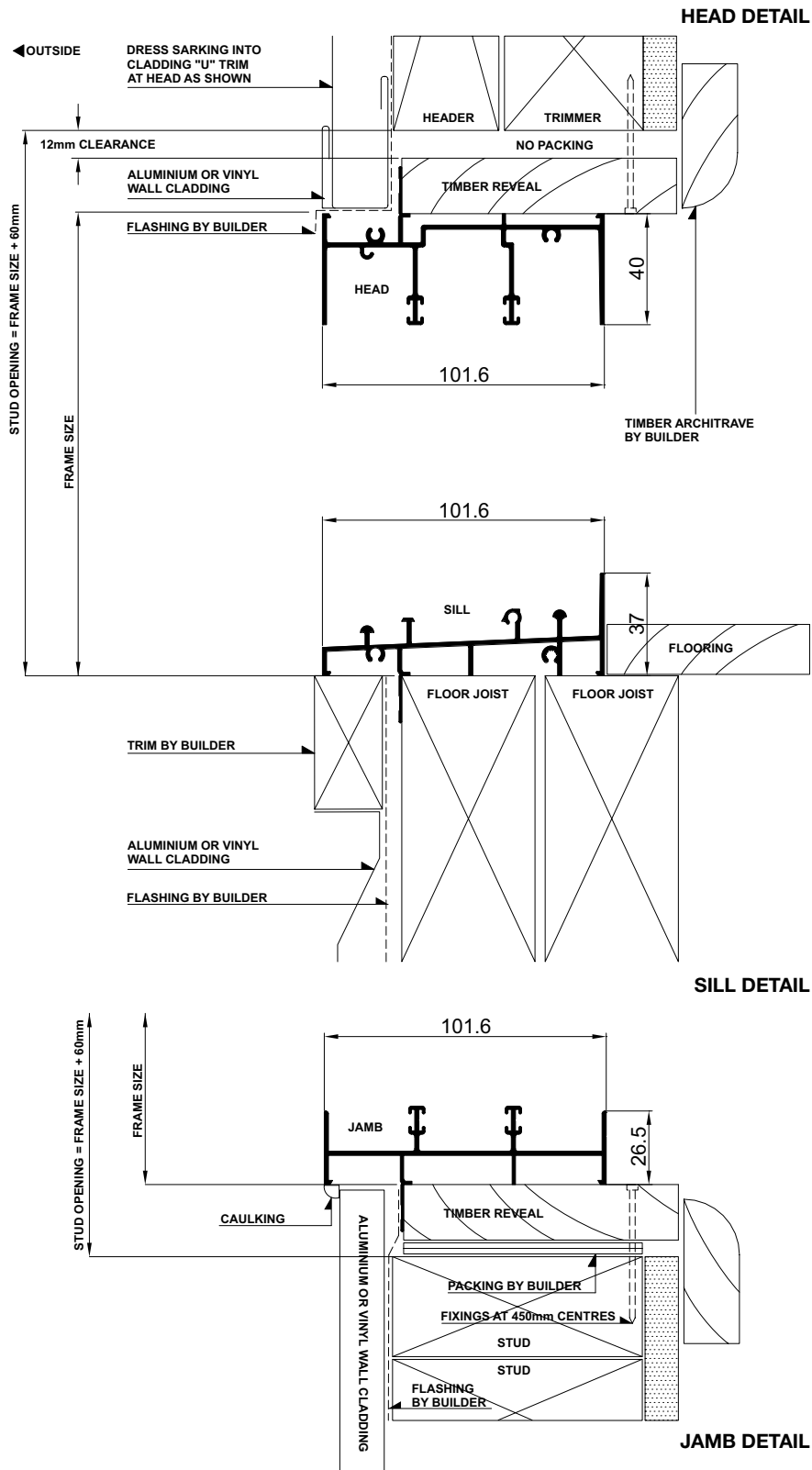

Please note that drawings are not to scale

Quantum® Sliding Door | QXD | Mk-4 | 1 Jul 2009

Confidentiality Notice: This document and the information it contains are copyright and confidential to Trend® Windows & Doors Pty Limited. Disclosure, use and copying in any form whatsoever, except as authorised by Trend® Windows & Doors in writing, are strictly prohibited. Patents and Design Registrations pending.

Cross Sectional Views

Quantum® Sliding Door | **Two Lite (FX)**

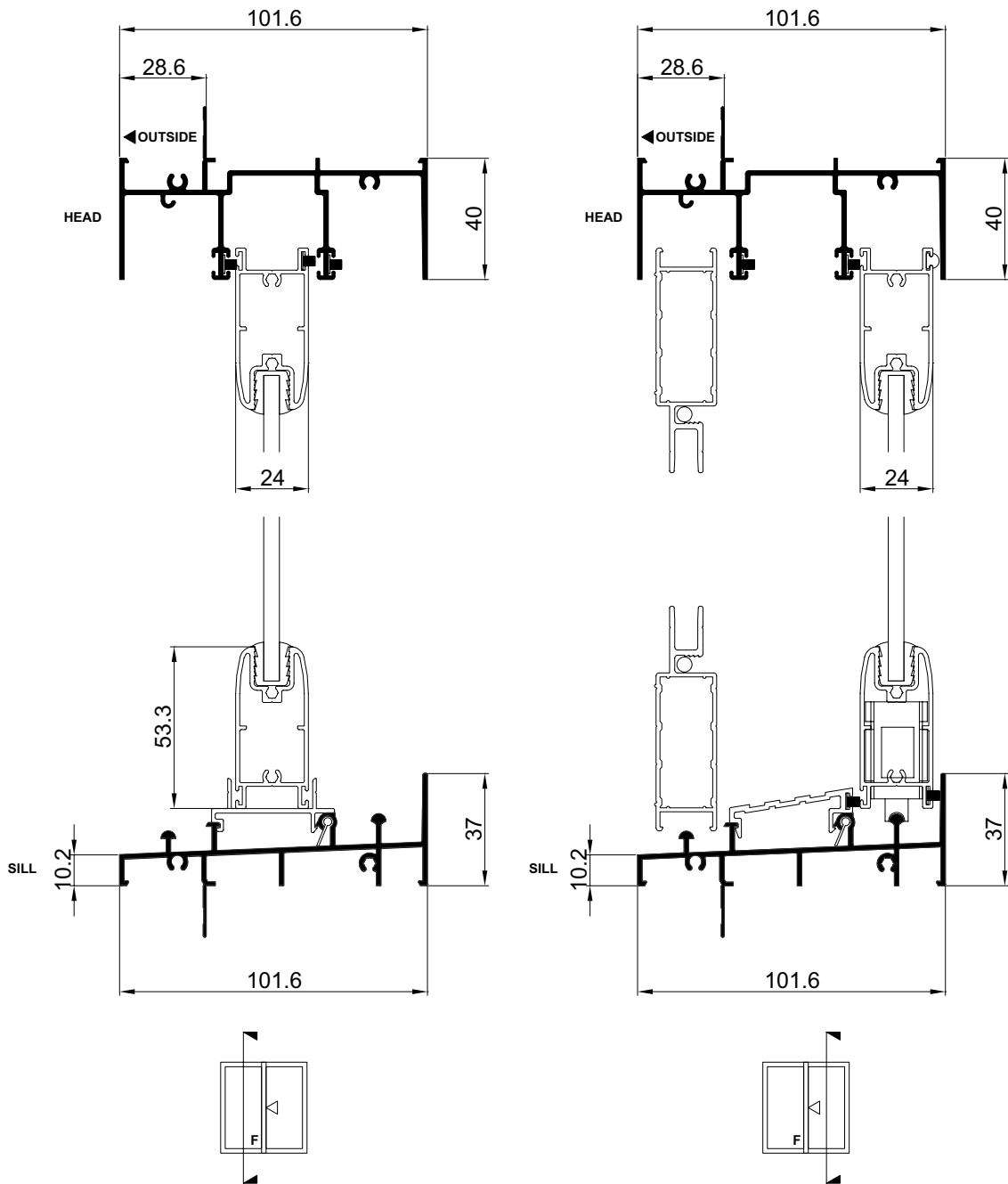

Please note that drawings are not to scale

Quantum® Sliding Door | QXD | Mk-4 | 1 Jul 2009

Confidentiality Notice: This document and the information it contains are copyright and confidential to Trend® Windows & Doors Pty Limited. Disclosure, use and copying in any form whatsoever, except as authorised by Trend® Windows & Doors in writing, are strictly prohibited. Patents and Design Registrations pending.

Cross Sectional Views

Quantum® Sliding Door | **Two Lite (FX)**

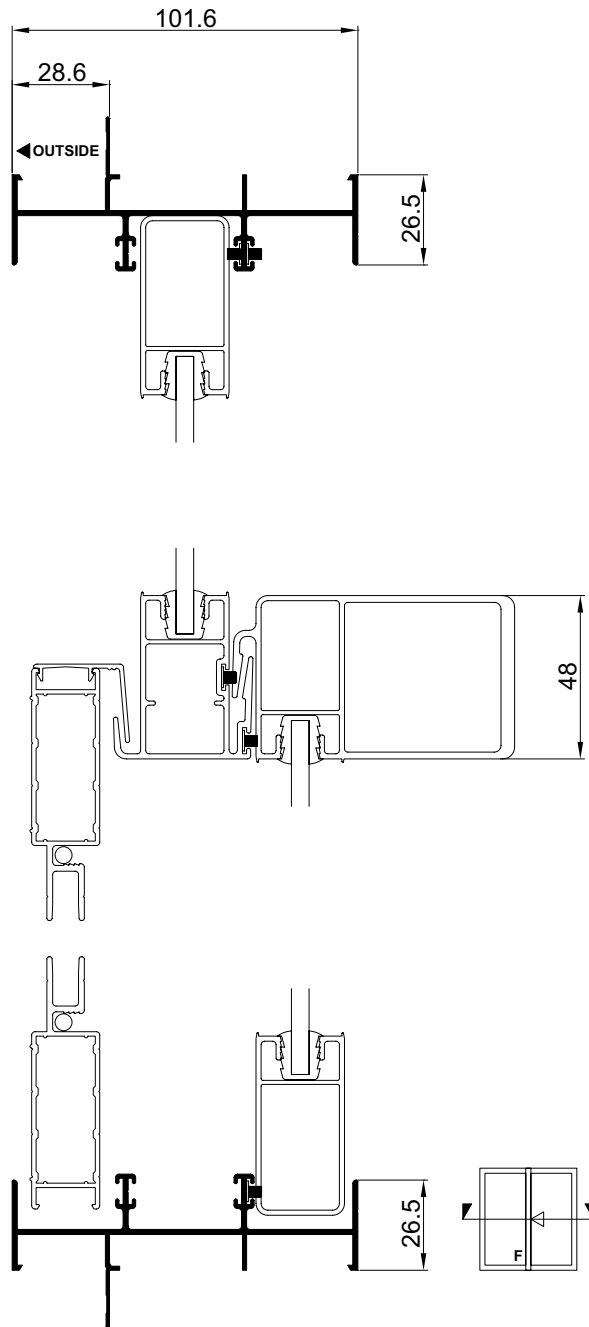

Please note that drawings are not to scale

Quantum® Sliding Door | QXD | Mk-4 | 1 Jul 2009

Confidentiality Notice: This document and the information it contains are copyright and confidential to Trend® Windows & Doors Pty Limited. Disclosure, use and copying in any form whatsoever, except as authorised by Trend® Windows & Doors in writing, are strictly prohibited. Patents and Design Registrations pending.

Cross Sectional Views

Quantum® Sliding Door | **Three Lite (FXF)**

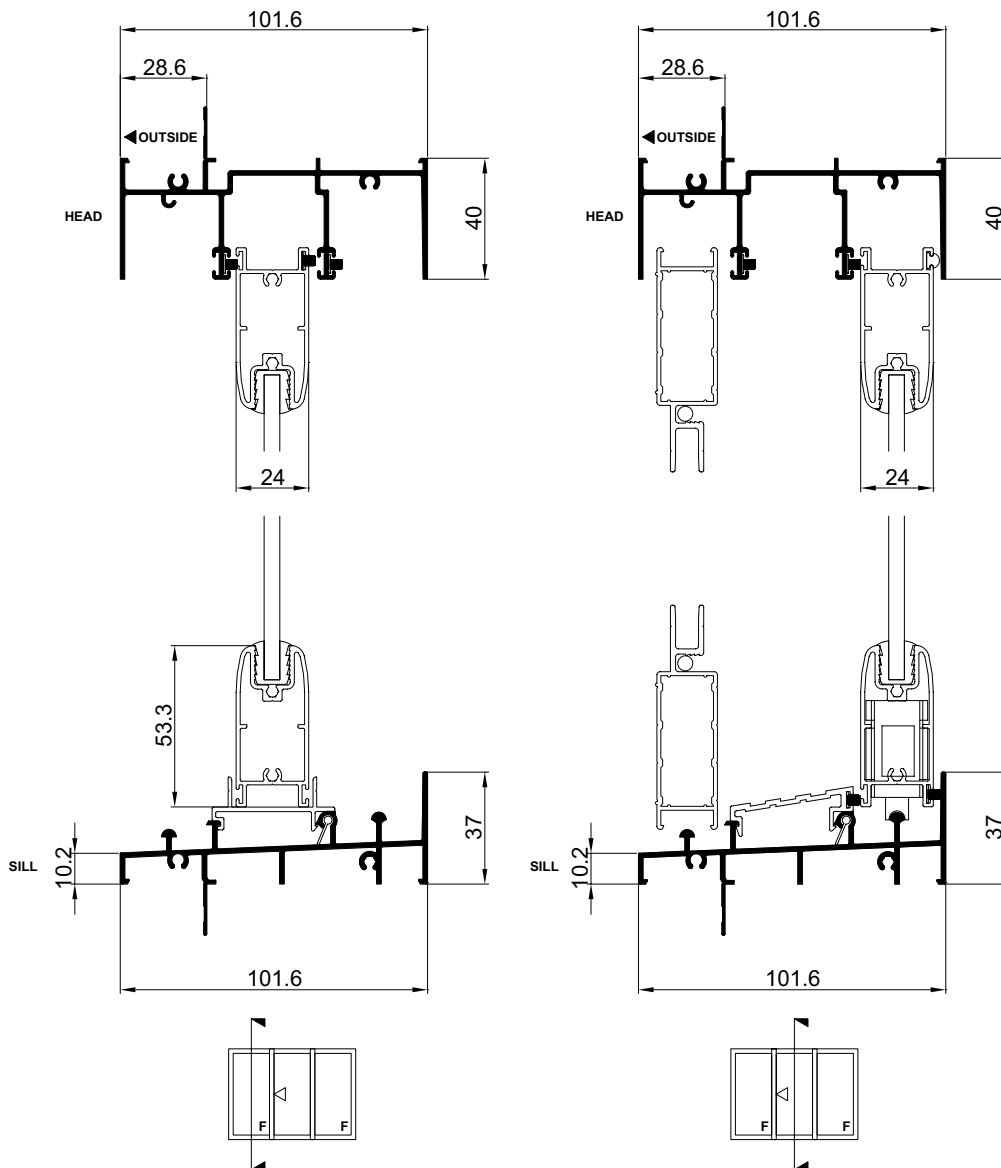

Please note that drawings are not to scale

Quantum® Sliding Door | QXD | Mk-4 | 1 Jul 2009

Confidentiality Notice: This document and the information it contains are copyright and confidential to Trend® Windows & Doors Pty Limited. Disclosure, use and copying in any form whatsoever, except as authorised by Trend® Windows & Doors in writing, are strictly prohibited. Patents and Design Registrations pending.

Cross Sectional Views

Quantum® Sliding Door | **Three Lite (FXF)**

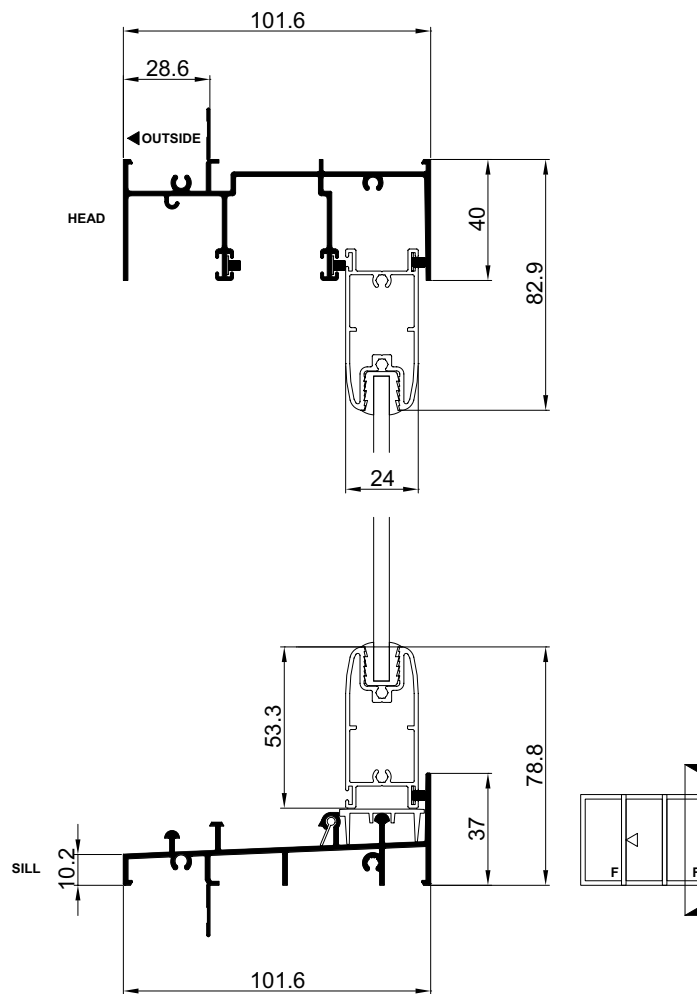

Please note that drawings are not to scale

Quantum® Sliding Door | QXD | Mk-4 | 1 Jul 2009

Confidentiality Notice: This document and the information it contains are copyright and confidential to Trend® Windows & Doors Pty Limited. Disclosure, use and copying in any form whatsoever, except as authorised by Trend® Windows & Doors in writing, are strictly prohibited. Patents and Design Registrations pending.

Cross Sectional Views

Quantum® Sliding Door | **Four Lite (FXXF)**

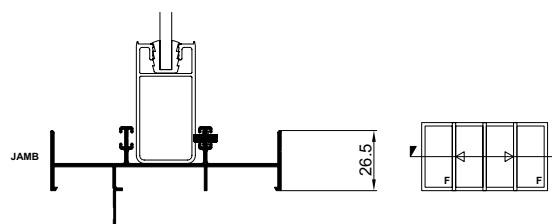
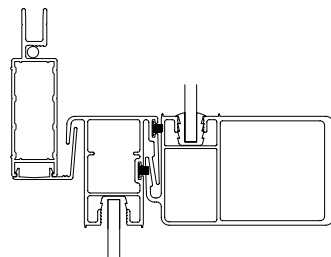
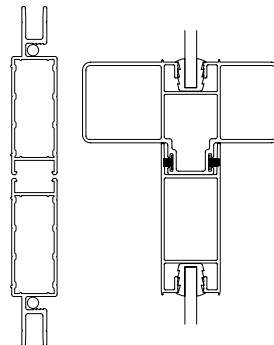
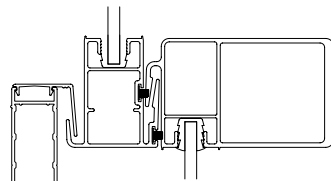
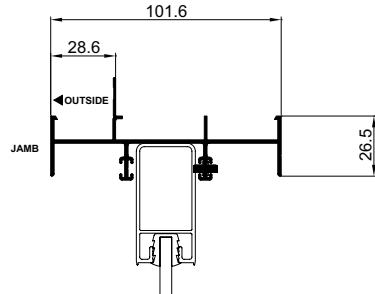

Please note that drawings are not to scale

Quantum® Sliding Door | QXD | Mk-4 | 1 Jul 2009

Cross Sectional Views

Quantum® Sliding Door | **Double Glazed**

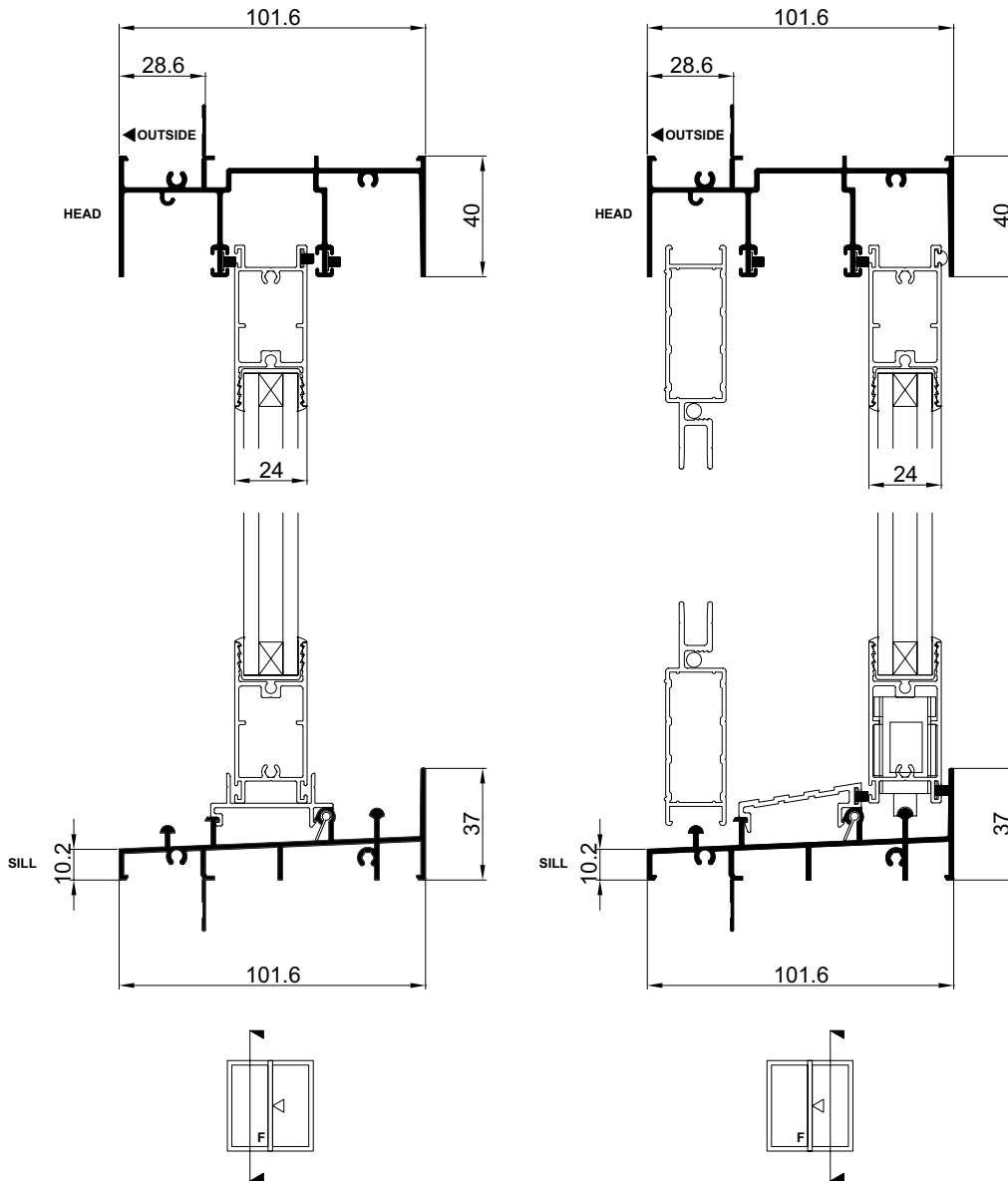

Please note that drawings are not to scale

Quantum® Sliding Door | QXD | Mk-4 | 1 Jul 2009

Confidentiality Notice: This document and the information it contains are copyright and confidential to Trend® Windows & Doors Pty Limited. Disclosure, use and copying in any form whatsoever, except as authorised by Trend® Windows & Doors in writing, are strictly prohibited. Patents and Design Registrations pending.

Cross Sectional Views

Quantum® Sliding Door | **Double Glazed**

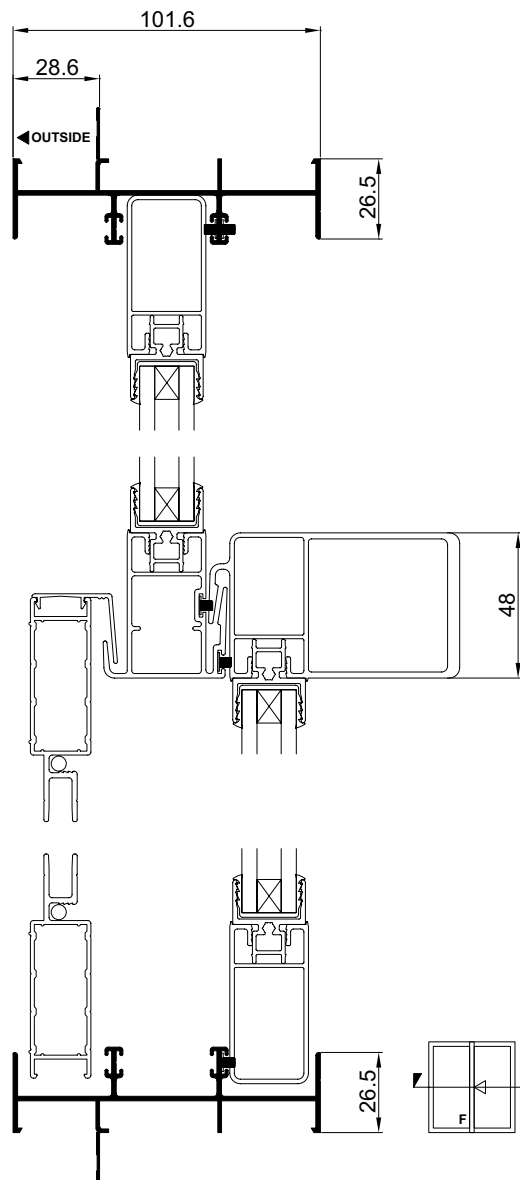

Please note that drawings are not to scale

Quantum® Sliding Door | QXD | Mk-4 | 1 Jul 2009