

Trend thermAL® Hybrid

Awning Window

TECHNICAL DATA

Features & Benefits

Size Range

Ordering Details

Installation

Cross Sectional Views

Features & Benefits

Trend thermAL® Awning Window

Glazing

Trend thermAL® is designed to accommodate upto 24mm double glazed units for maximum energy efficiency. With over 60 different glazing options there is a solution for any climate in Australia.

Among the lowest U-Values and SHGC available but at a significantly lower cost when compared to similar systems.

U-Value down to 2.5
SHGC wide range of 0.53 - 0.27
Cooling Efficiency 67%
Heating Efficiency 72%

Composition

Aluminium external surface for maximum strength which can be powder coated in a range of standard and designer colours for a bold external finish

Rigid polymer ERP™ is available in 3 standard steadfast colours to complement internal finishes with a subtle appearance but complementing the external finish.

Rigid polymer ERP™ internal surface designed to reduce energy transfer for highest energy efficiency

Rigid polymer ERP™ is impact modified to ensure minimal damage even during construction.

Rigid polymer ERP™ is pre-stressed to eliminate excessive shrinkage or expansion and is also UV stabilised to withstand the harsh Australian climates

Key Lock Scissor Winder

Trend thermAL® Awning window Secura winder mechanism is designed specifically for high performance, security and reliability.

The Trend thermAL® winder can be used in even the harshest environment without worry of corrosion.

Secura hardware is available in powder coat finishes with stainless steel stay mechanism.

Restricted openers to 100mm are available for safety options.

Keyed lock is standard for added security.

Window Placement

Care should be taken with locating opening awning windows in pedestrian traffic areas.

Protective Wrapping

Protective wrapping for delivery to site is a standard for all Trend thermAL® products.

Options

Easy to fit flyscreens can be fitted and removed from the inside.

Wide range of powdercoat finishes available including timber powdercoat finishes.

ERP™ Colours

Anodic Natural Matt
White
Matt Stone Beige

Maximum Size

Maximum size of single Awning is 2100mm (h) x 910mm (w)

Trend thermAL® Awning have tested and passed the BAL-40 (Bushfire Attack Level) to withstand up to 40kW/m² of heat flux in bushfire areas

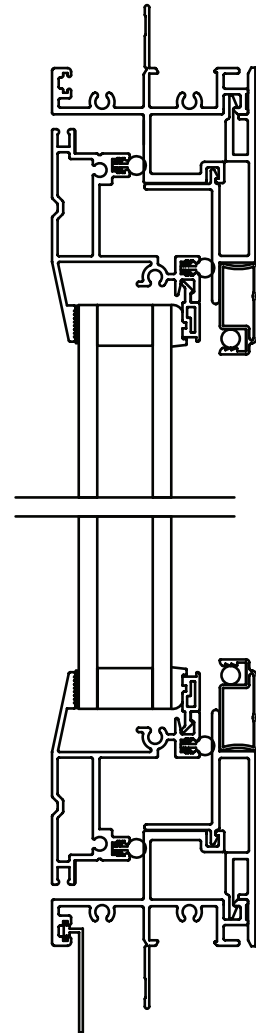





































































Please note that drawings are not to scale

Trend thermAL® Awning Window | TAA | Mk-1 | 1 June 2011

Size Range

Trend thermAL® Awning Window

		666	966	1266	1566	1866	2166	2466	2766
		610	910	1210	1510	1810	2110	2410	2710
STUD OPENING WINDOW	656 600	 TAA0606	 TAA0609	 TAA0612	 TAA0615	 TAA0618	 TAA0621	 TAA0624	 TAA0627
	956 900	 TAA0906	 TAA0909	 TAA0912	 TAA0915	 TAA0918	 TAA0921	 TAA0924	 TAA0927
	1056 1000	 TAA1006	 TAA1009	 TAA1012	 TAA1015	 TAA1018	 TAA1021	 TAA1024	 TAA1027
	1256 1200	 TAA1206	 TAA1209	 TAA1212	 TAA1215	 TAA1218	 TAA1221	 TAA1224	 TAA1227
	1421 1365	 TAA1406	 TAA1409	 TAA1412	 TAA1415	 TAA1418	 TAA1421	 TAA1424	 TAA1427
	1856 1800	 TAA1806	 TAA1809	 TAA1815	 TAA1818	 TAA1824	 TAA1827		
	2156 2100	 TAA2106	 TAA2109	 TAA2115	 TAA2118	 TAA2124	 TAA2127		
	1856 1800	 TAA1806T	 TAA1809T	 TAA1812T	 TAA1815T	 TAA1818T	 TAA1821T	 TAA1824T	 TAA1827T
	2156 2100	 TAA2106T	 TAA2109T	 TAA2112T	 TAA2115T	 TAA2118T	 TAA2121T	 TAA2124T	 TAA2127T

All windows and doors are designed to 700pa velocity and 200pa water rating. For higher ratings consult Trend Windows & Doors

NOTES

Hinged from the top, the sash of the Trend thermAL® awning windows swings out from the bottom, giving your home good ventilation – even in wet weather. The sash design offers a wide viewing area, while its excellent sealing

qualities ensure added climate control. In gusty conditions, the sturdy scissor winder mechanism prevents the window slamming.

For information on double-glazing or wind ratings, please contact Trend® Windows &

Doors Sales Representative.

ERP™ Colors are Anodic Natural Matt, White & Matt Stone Beige

Please note that drawings are not to scale

Trend thermAL® Awning Window | TAA | Mk-1 | 1 June 2011

Confidentiality Notice: This document and the information it contains are copyright and confidential to Trend® Windows & Doors Pty Limited. Disclosure, use and copying in any form whatsoever, except as authorised by Trend® Windows & Doors in writing, are strictly prohibited. Patents and Design Registrations pending.

Ordering Details

Trend thermAL® Awning Window

All windows are illustrated as viewed from outside. Codes shown are for plain windows.

Manufactured from aluminium and Rigid Polymer extrusion.

The first two numbers of code indicate approximate height, the last two numbers indicate approximate width.

Sash Style Options:
Standard option, eg window code TAA0906

Configuration Options:
F indicates Fixed
LF indicates Left Hand\Fixed
FR indicates Fixed\RightHand
FF indicates Fixed\Fixed
LFR indicates Left Hand\Fixed\Right Hand
FLF indicates Fixed\Left Hand\Fixed
FRF indicates Fixed\Right Hand\Fixed
FFF indicates Fixed\Fixed\Fixed
T after the size indicates a Transom

Please note that drawings are not to scale

Trend thermAL® Awning Window | TAA | Mk-1 | 1 June 2011

Confidentiality Notice: This document and the information it contains are copyright and confidential to Trend® Windows & Doors Pty Limited. Disclosure, use and copying in any form whatsoever, except as authorised by Trend® Windows & Doors in writing, are strictly prohibited. Patents and Design Registrations pending.

Installation

Trend thermAL® Awning Window | Building In Detail | **Brick Veneer - 230mm wall**

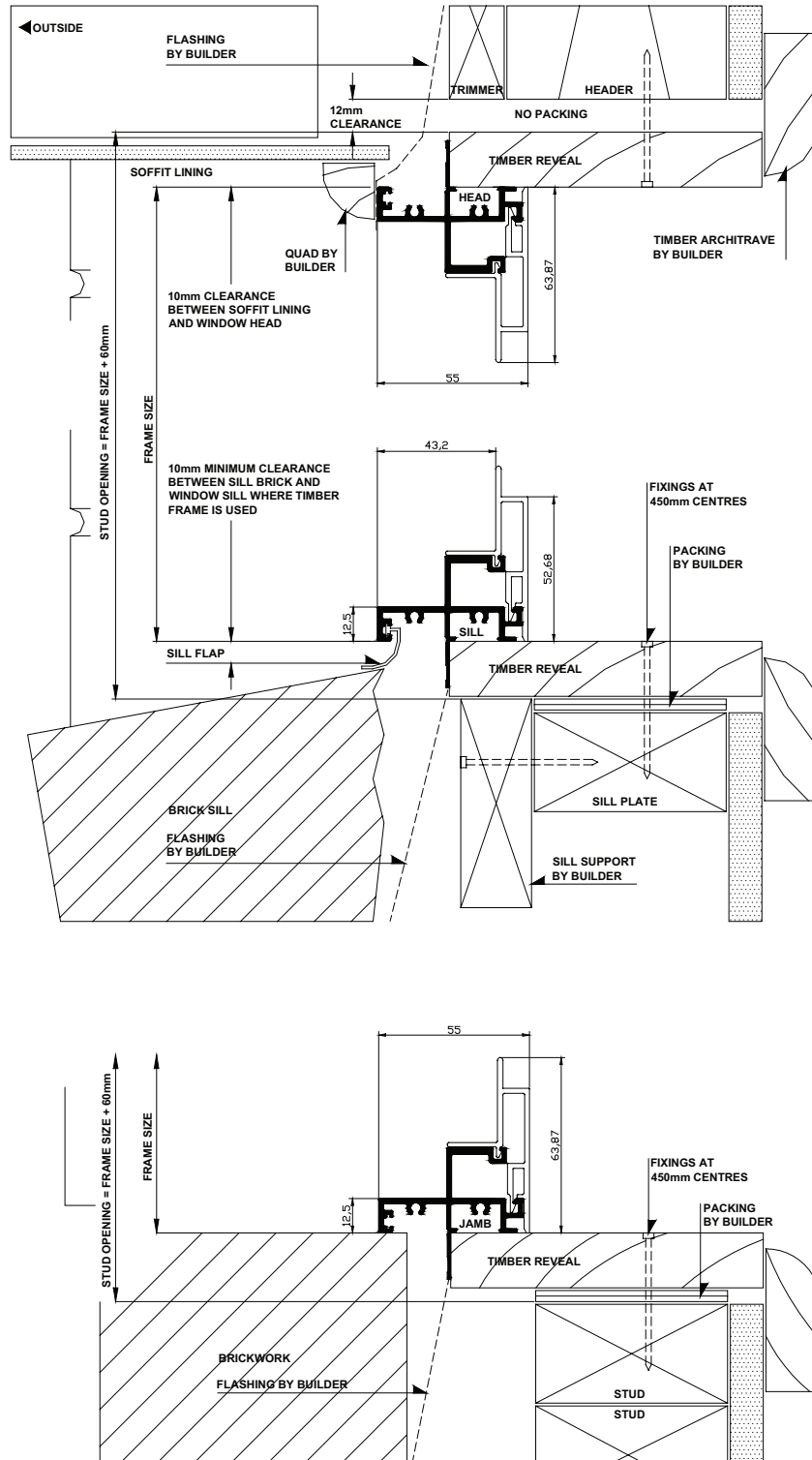

Please note that drawings are not to scale

Trend thermAL® Awning Window | TAA | Mk-1 | 1 June 2011

Confidentiality Notice: This document and the information it contains are copyright and confidential to Trend® Windows & Doors Pty Limited. Disclosure, use and copying in any form whatsoever, except as authorised by Trend® Windows & Doors in writing, are strictly prohibited. Patents and Design Registrations pending.

Installation

Trend thermAL® Awning Window | Building In Detail | **Double Brick - 280mm wall**

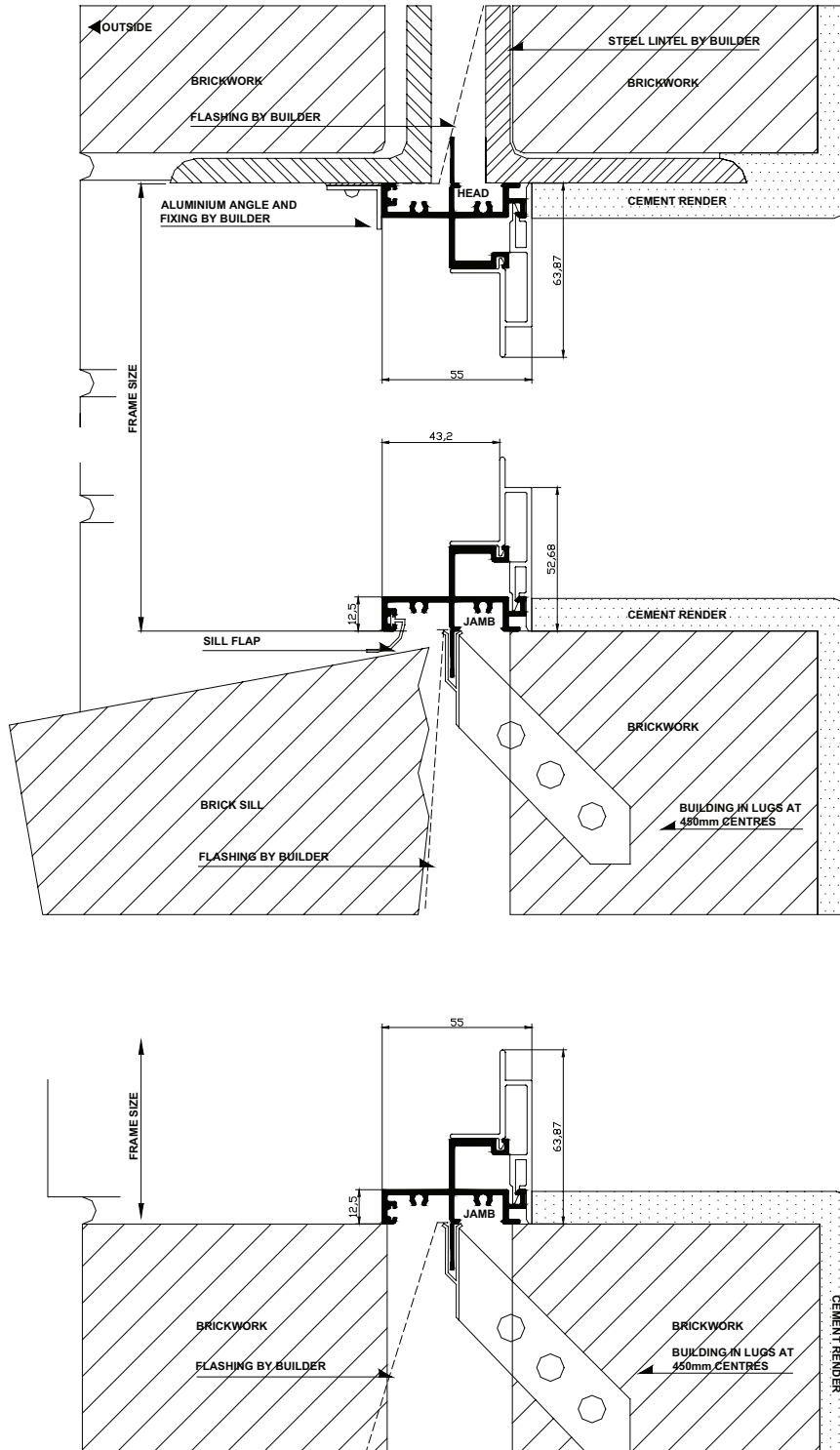

Please note that drawings are not to scale

Trend thermAL® Awning Window | TAA | Mk-1 | 1 June 2011

Confidentiality Notice: This document and the information it contains are copyright and confidential to Trend® Windows & Doors Pty Limited. Disclosure, use and copying in any form whatsoever, except as authorised by Trend® Windows & Doors in writing, are strictly prohibited. Patents and Design Registrations pending.

Installation

Trend thermAL® Awning Window | Building In Detail | Aluminium Cladding on Studs

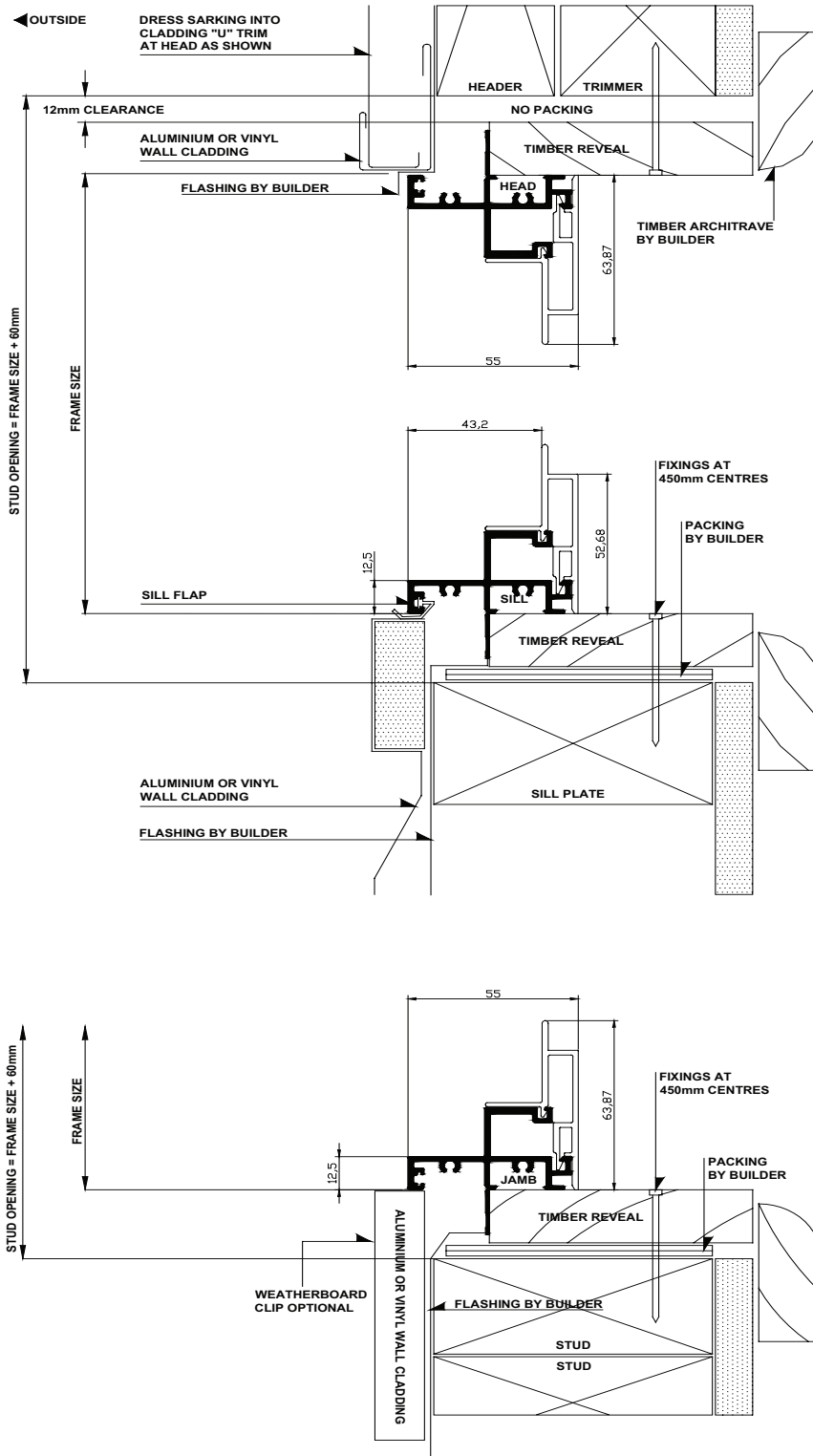

Please note that drawings are not to scale

Trend thermAL® Awning Window | TAA | Mk-1 | 1 June 2011

Confidentiality Notice: This document and the information it contains are copyright and confidential to Trend® Windows & Doors Pty Limited. Disclosure, use and copying in any form whatsoever, except as authorised by Trend® Windows & Doors in writing, are strictly prohibited. Patents and Design Registrations pending.

Cross Sectional Views

Trend thermAL® Awning Window | **Awning Single Lite - Double Glazed**

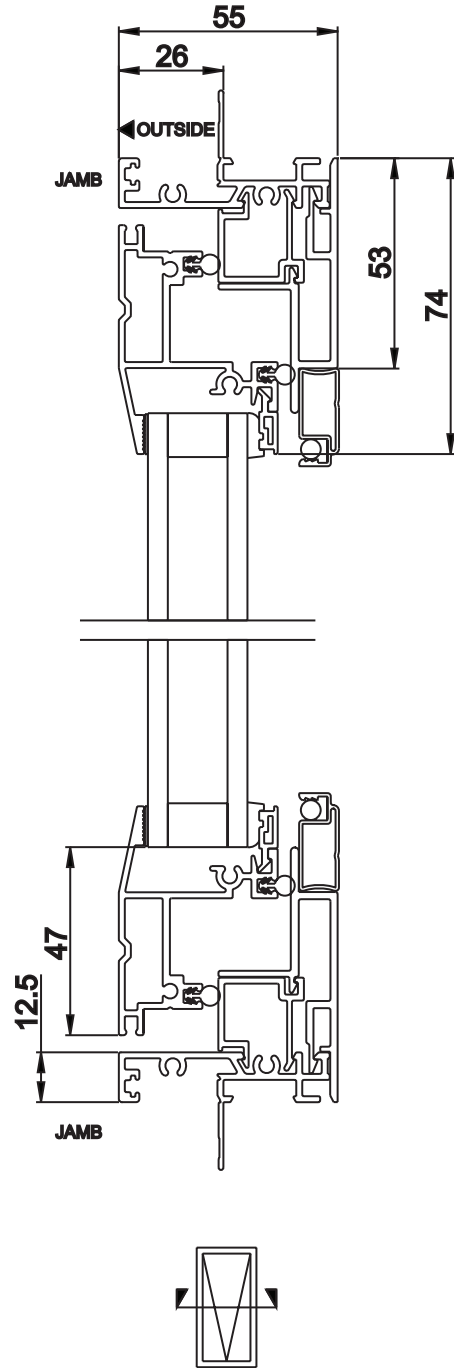
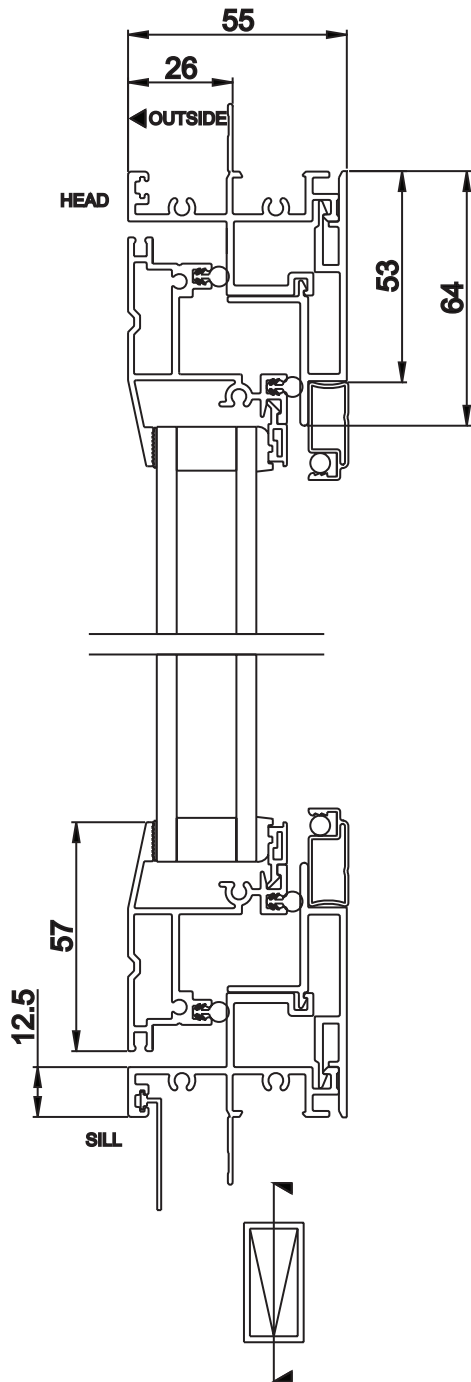

Please note that drawings are not to scale

Trend thermAL® Awning Window | TAA | Mk-1 | 1 June 2011

Confidentiality Notice: This document and the information it contains are copyright and confidential to Trend® Windows & Doors Pty Limited. Disclosure, use and copying in any form whatsoever, except as authorised by Trend® Windows & Doors in writing, are strictly prohibited. Patents and Design Registrations pending.

Cross Sectional Views

Trend thermAL® Awning Window | **Awning/Fixed with Low Lite - Double Glazed**

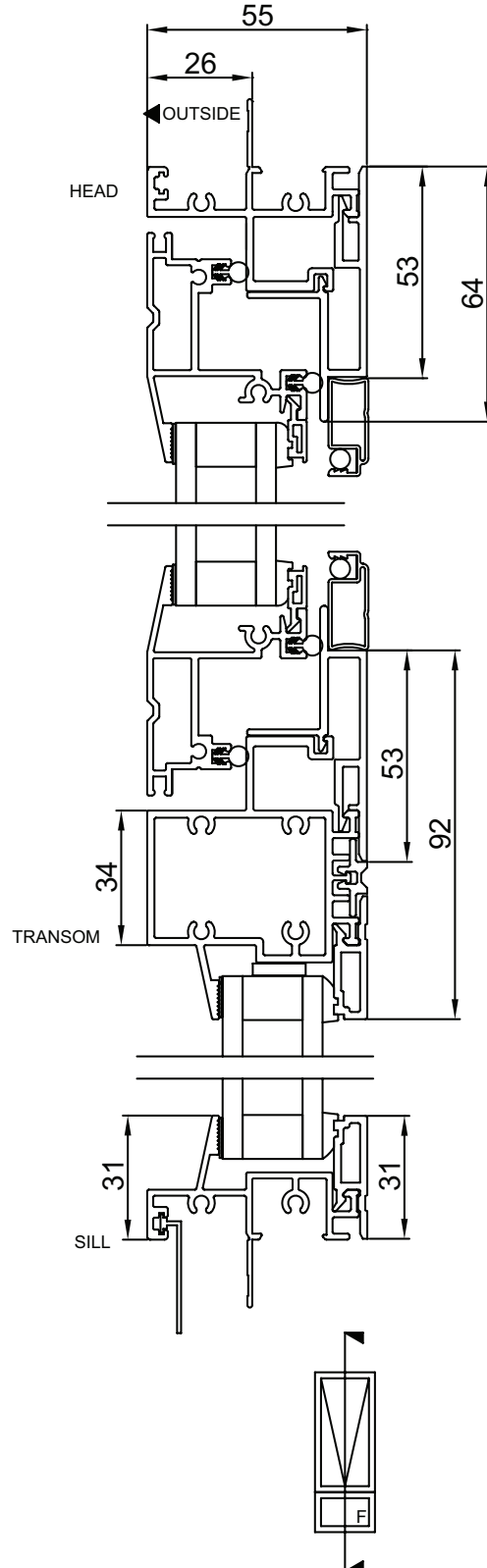

Please note that drawings are not to scale

Trend thermAL® Awning Window | TAA | Mk-1 | 1 June 2011

Confidentiality Notice: This document and the information it contains are copyright and confidential to Trend® Windows & Doors Pty Limited. Disclosure, use and copying in any form whatsoever, except as authorised by Trend® Windows & Doors in writing, are strictly prohibited. Patents and Design Registrations pending.

Cross Sectional Views

Trend thermAL® Awning Window | **Awning with Fixed Low Lite - Double Glazed**

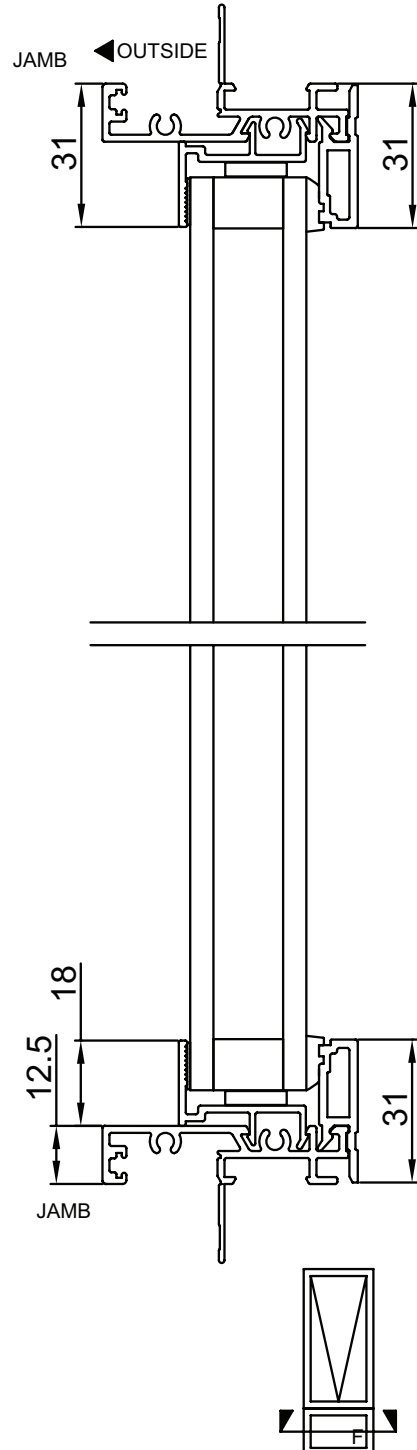
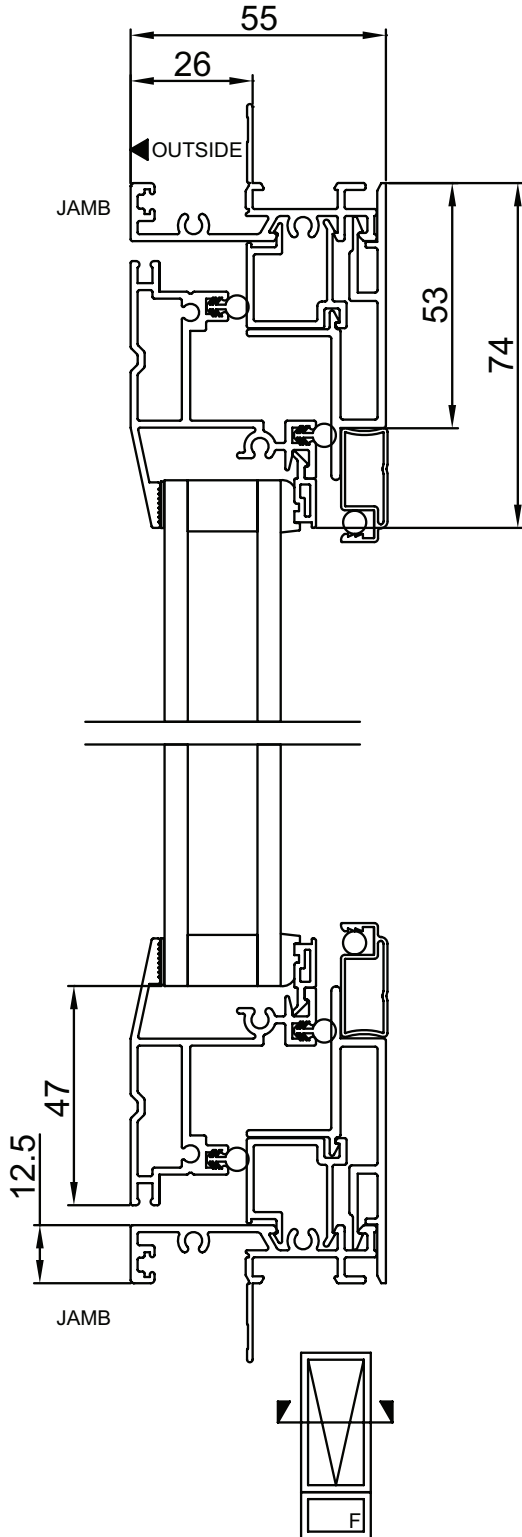

Please note that drawings are not to scale

Trend thermAL® Awning Window | TAA | Mk-1 | 1 June 2011

Confidentiality Notice: This document and the information it contains are copyright and confidential to Trend® Windows & Doors Pty Limited. Disclosure, use and copying in any form whatsoever, except as authorised by Trend® Windows & Doors in writing, are strictly prohibited. Patents and Design Registrations pending.

Cross Sectional Views

Trend thermAL® Awning Window | **Awning/Fixed - Double Glazed**

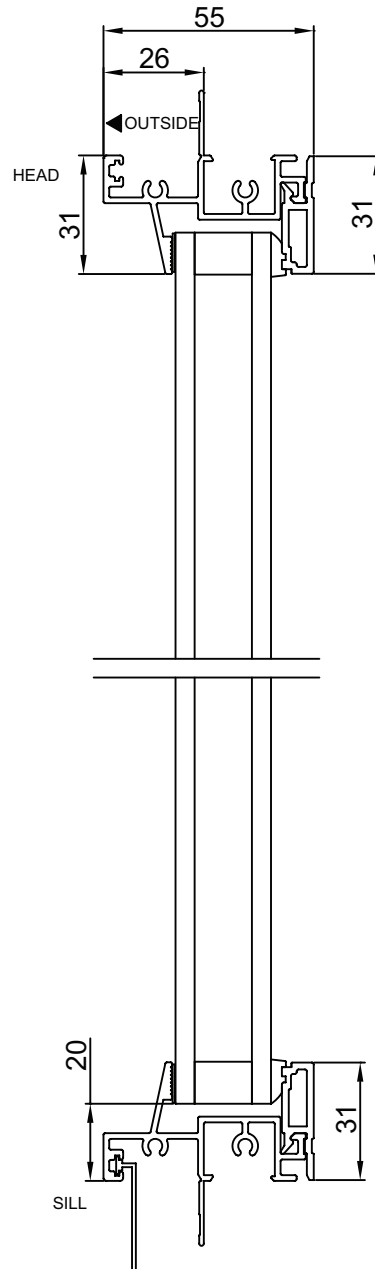
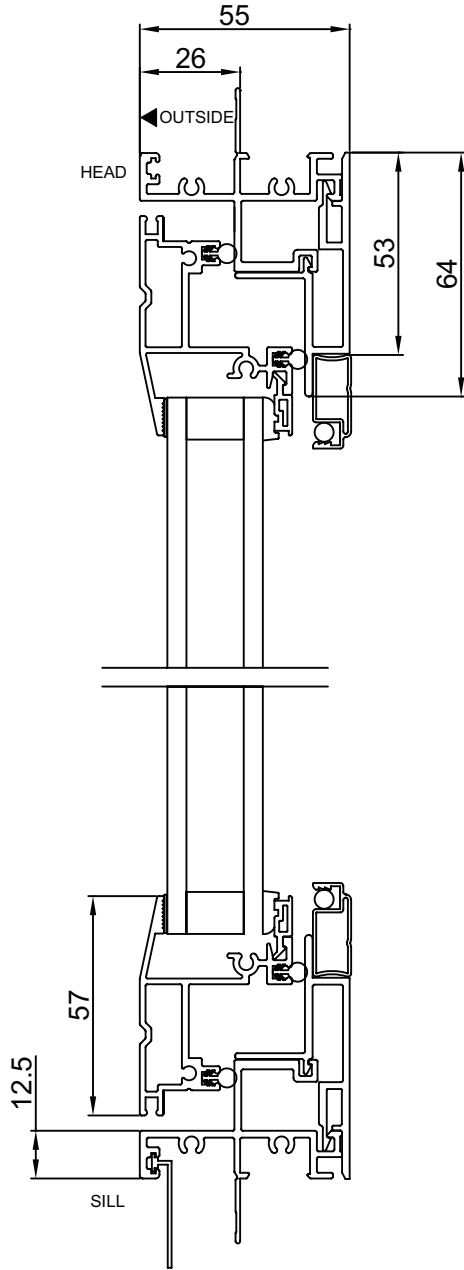

Please note that drawings are not to scale

Trend thermAL® Awning Window | TAA | Mk-1 | 1 June 2011

Confidentiality Notice: This document and the information it contains are copyright and confidential to Trend® Windows & Doors Pty Limited. Disclosure, use and copying in any form whatsoever, except as authorised by Trend® Windows & Doors in writing, are strictly prohibited. Patents and Design Registrations pending.

Cross Sectional Views

Trend thermAL® Awning Window | **Awning/Fixed - Double Glazed**

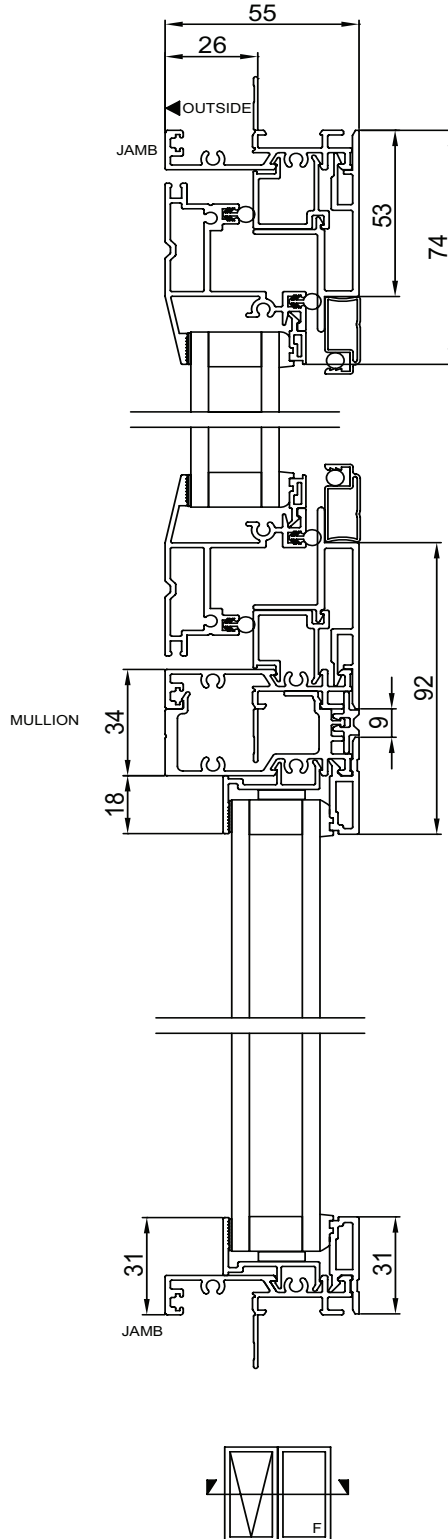

Please note that drawings are not to scale

Trend thermAL® Awning Window | TAA | Mk-1 | 1 June 2011

Confidentiality Notice: This document and the information it contains are copyright and confidential to Trend® Windows & Doors Pty Limited. Disclosure, use and copying in any form whatsoever, except as authorised by Trend® Windows & Doors in writing, are strictly prohibited. Patents and Design Registrations pending.

Cross Sectional Views

Trend thermAL® Awning Window | **Awning/Fixed with Fixed Low Lite - Double Glazed**

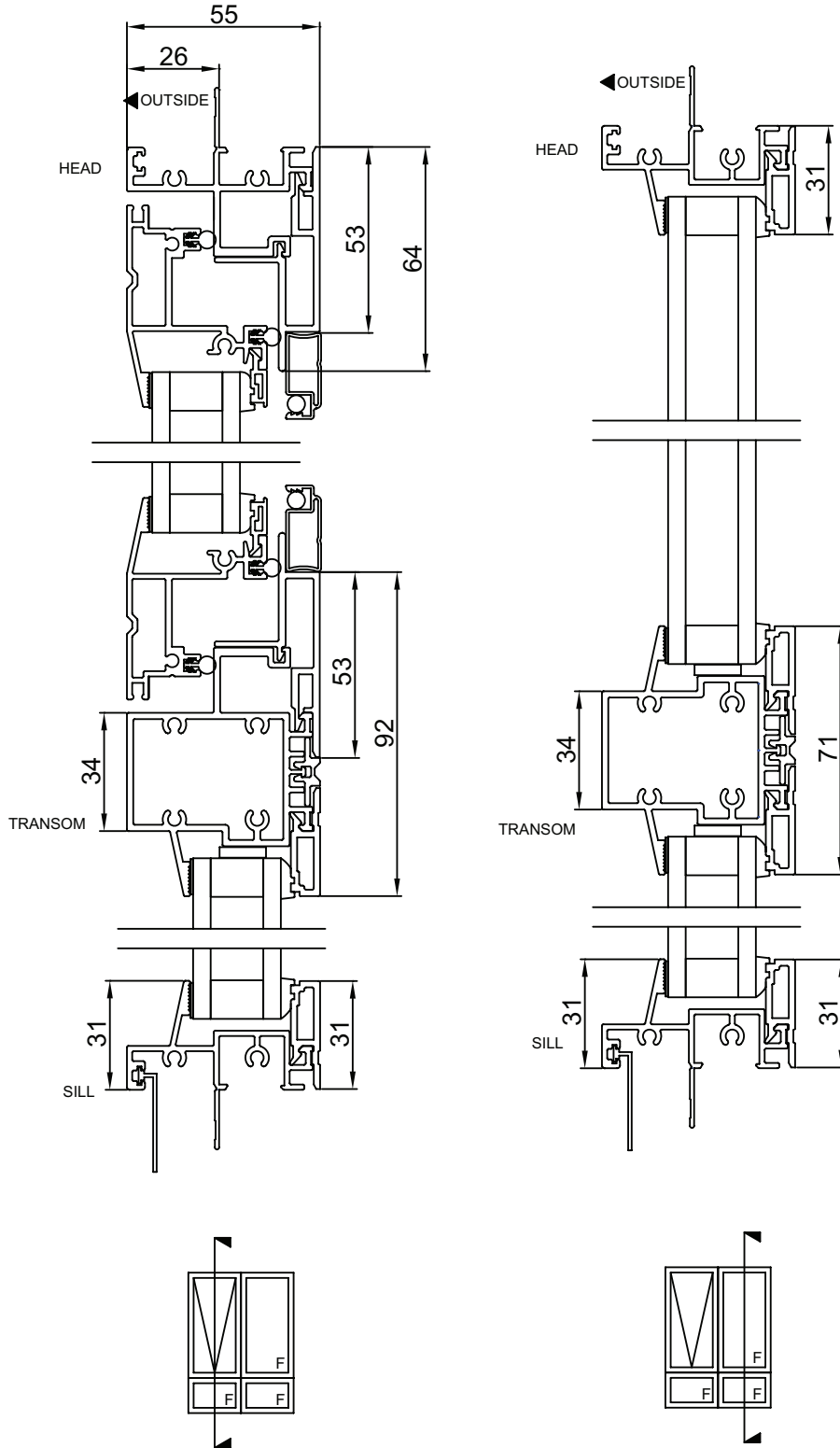

Please note that drawings are not to scale

Trend thermAL® Awning Window | TAA | Mk-1 | 1 June 2011

Confidentiality Notice: This document and the information it contains are copyright and confidential to Trend® Windows & Doors Pty Limited. Disclosure, use and copying in any form whatsoever, except as authorised by Trend® Windows & Doors in writing, are strictly prohibited. Patents and Design Registrations pending.

Cross Sectional Views

Trend thermAL® Awning Window | **Awning/Fixed with Low Lite - Double Glazed**

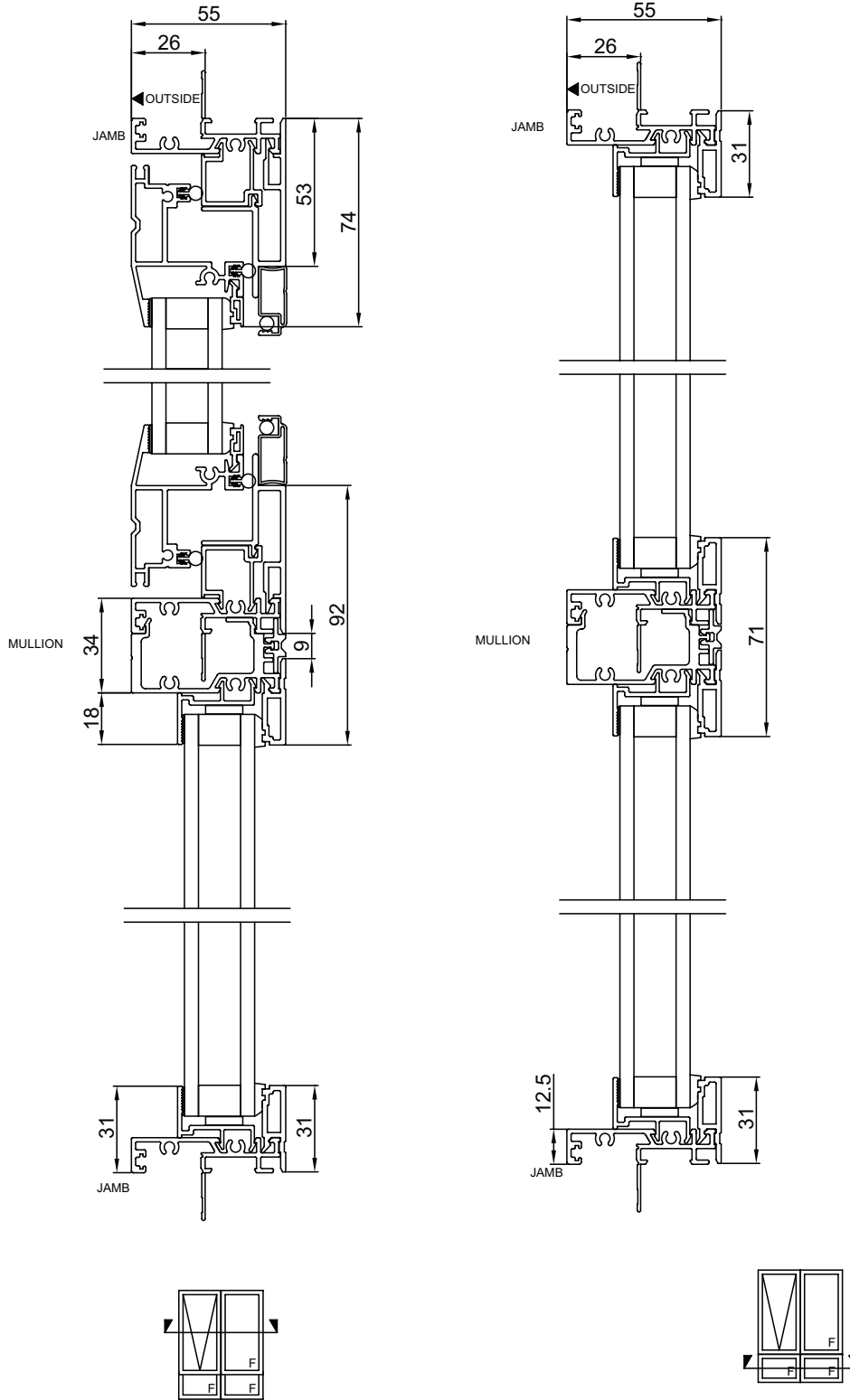

Please note that drawings are not to scale

Trend thermAL® Awning Window | TAA | Mk-1 | 1 June 2011

Confidentiality Notice: This document and the information it contains are copyright and confidential to Trend® Windows & Doors Pty Limited. Disclosure, use and copying in any form whatsoever, except as authorised by Trend® Windows & Doors in writing, are strictly prohibited. Patents and Design Registrations pending.

Cross Sectional Views

Trend thermAL® Awning Window | **Awning/Fixed/Awning - Double Glazed**

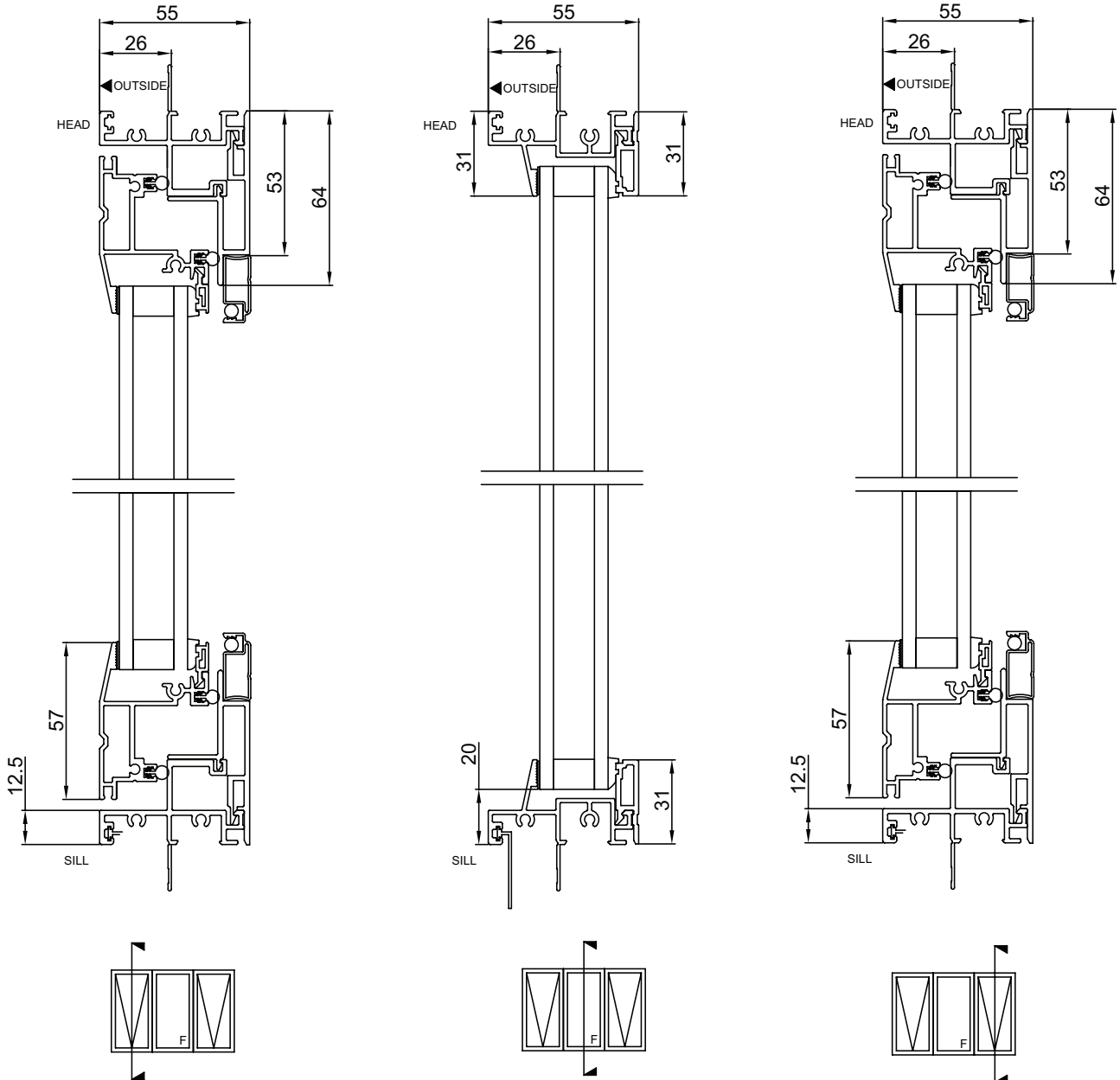

Please note that drawings are not to scale

Trend thermAL® Awning Window | TAA | Mk-1 | 1 June 2011

Confidentiality Notice: This document and the information it contains are copyright and confidential to Trend® Windows & Doors Pty Limited. Disclosure, use and copying in any form whatsoever, except as authorised by Trend® Windows & Doors in writing, are strictly prohibited. Patents and Design Registrations pending.

Cross Sectional Views

Trend thermAL® Awning Window | **Awning/Fixed/Awning - Double Glazed**

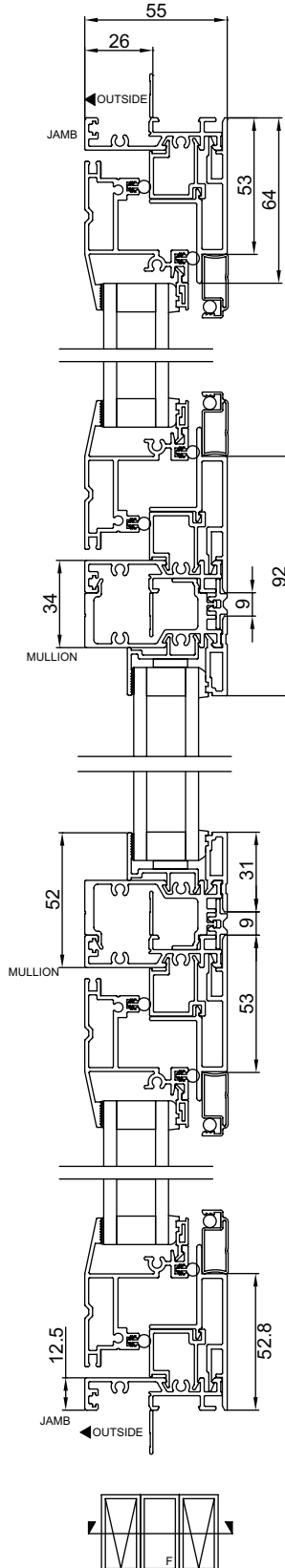

Please note that drawings are not to scale

Trend thermAL® Awning Window | TAA | Mk-1 | 1 June 2011

Confidentiality Notice: This document and the information it contains are copyright and confidential to Trend® Windows & Doors Pty Limited. Disclosure, use and copying in any form whatsoever, except as authorised by Trend® Windows & Doors in writing, are strictly prohibited. Patents and Design Registrations pending.

Cross Sectional Views

Trend thermAL® Awning Window | **Awning/Fixed/Awning with Low Lite - Double Glazed**

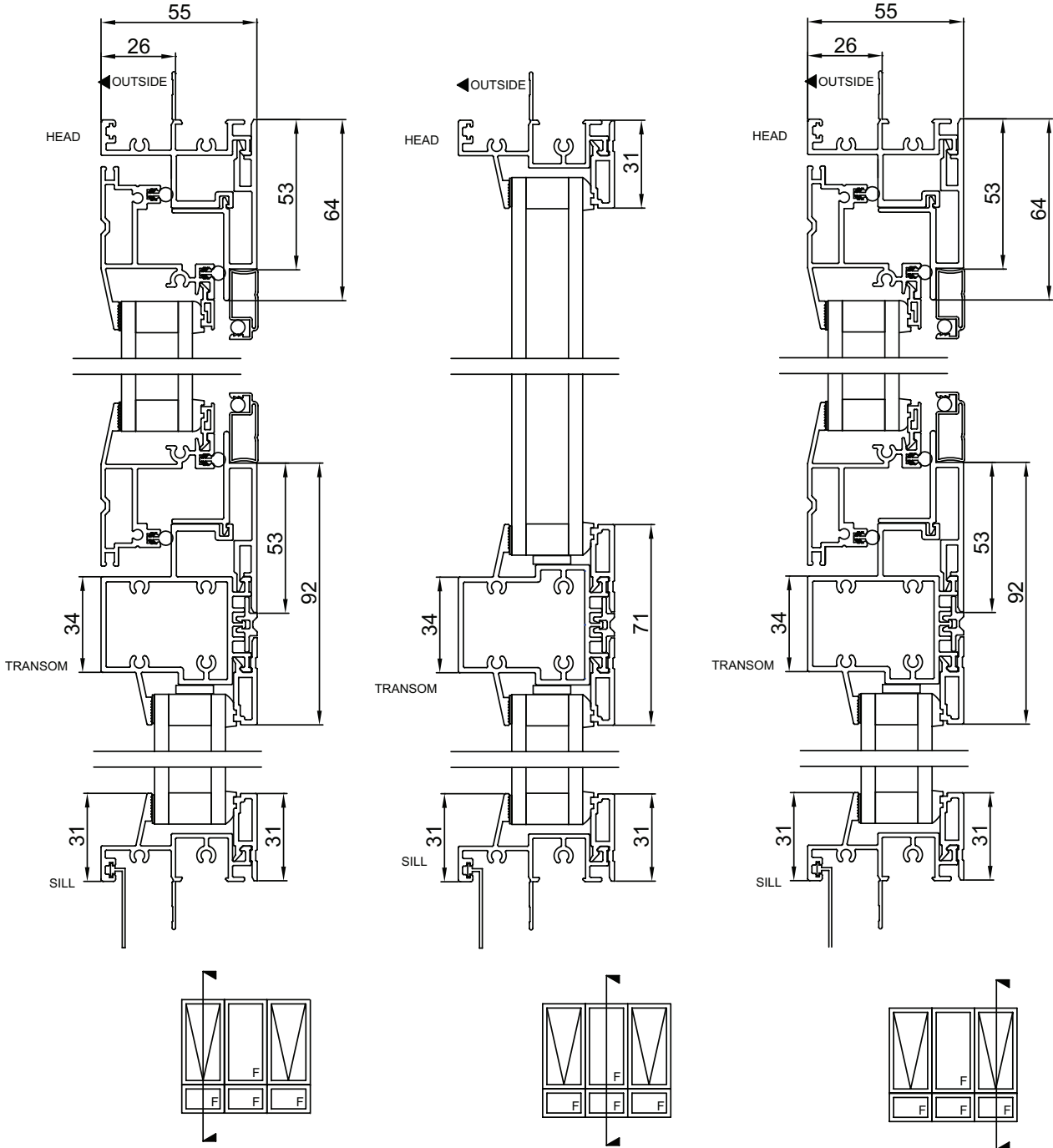

Please note that drawings are not to scale

Trend thermAL® Awning Window | TAA | Mk-1 | 1 June 2011

Confidentiality Notice: This document and the information it contains are copyright and confidential to Trend® Windows & Doors Pty Limited. Disclosure, use and copying in any form whatsoever, except as authorised by Trend® Windows & Doors in writing, are strictly prohibited. Patents and Design Registrations pending.

Cross Sectional Views

Trend thermAL® Awning Window | **Awning/Fixed/Awning with Low Lite - Double Glazed**

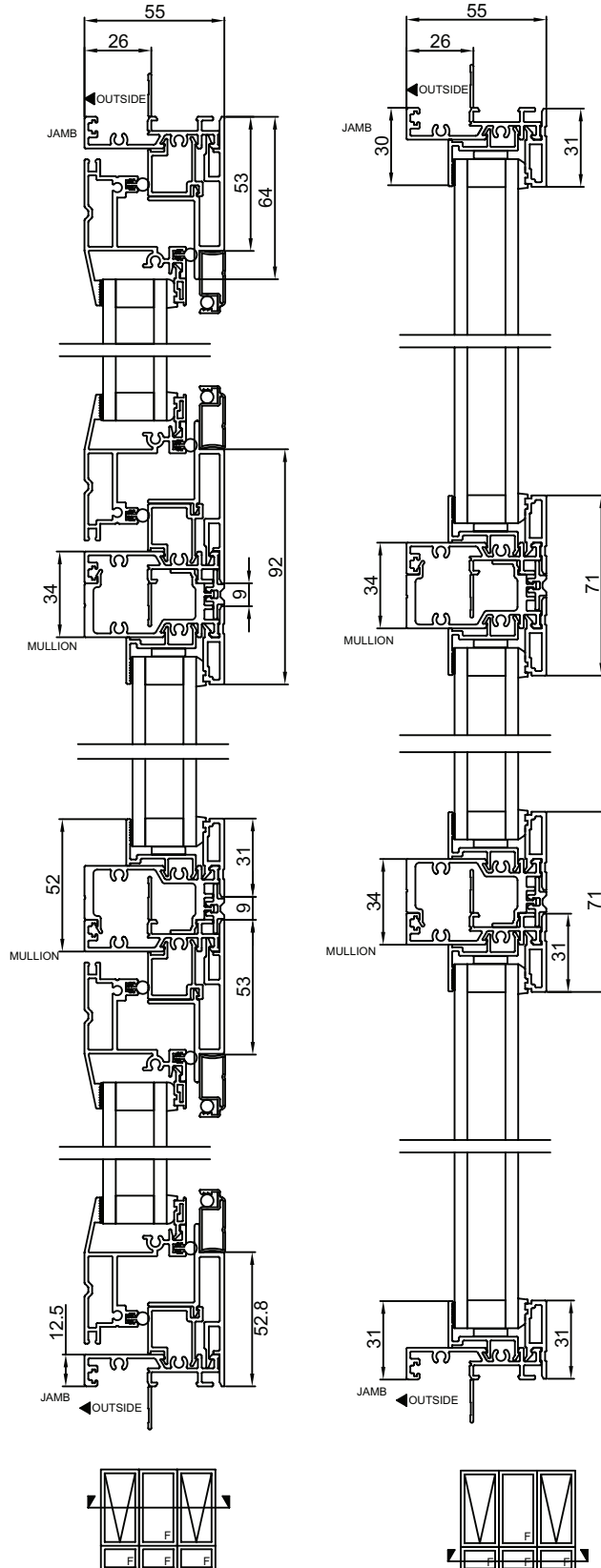

Please note that drawings are not to scale

Trend thermAL® Awning Window | TAA | Mk-1 | 1 June 2011

Confidentiality Notice: This document and the information it contains are copyright and confidential to Trend® Windows & Doors Pty Limited. Disclosure, use and copying in any form whatsoever, except as authorised by Trend® Windows & Doors in writing, are strictly prohibited. Patents and Design Registrations pending.